

Carex[®]
caring for you

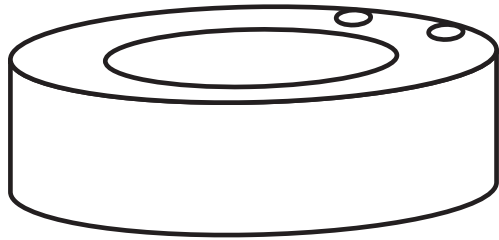

B306
B307

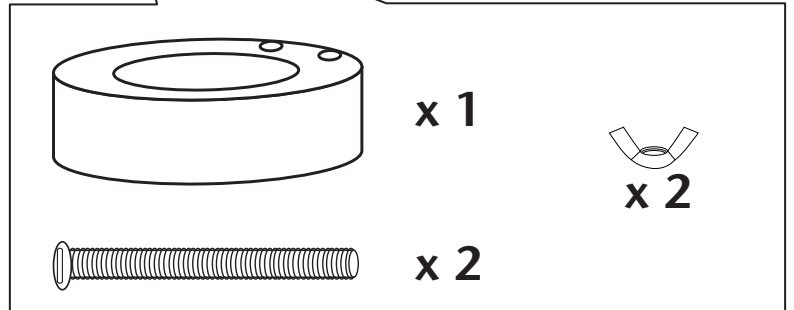
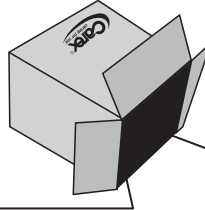
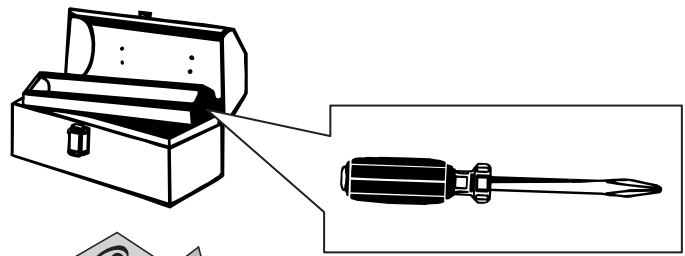

1

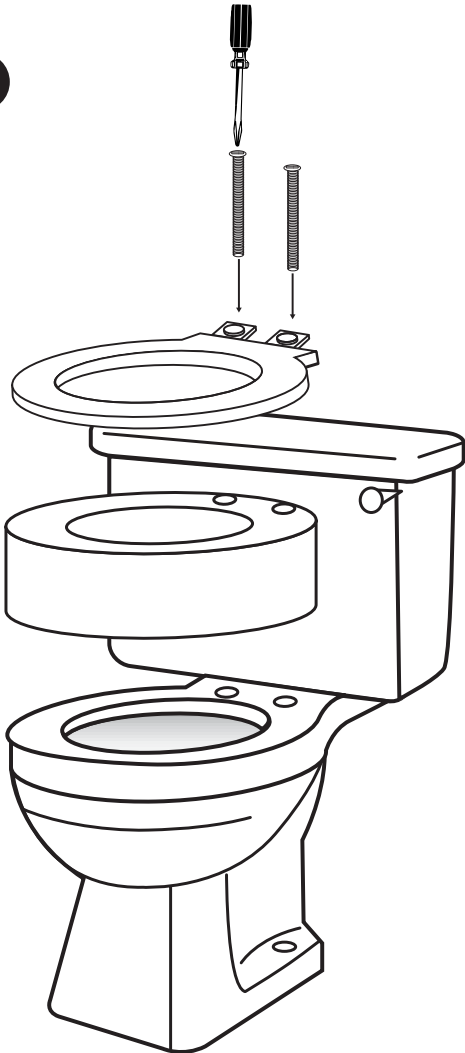

2

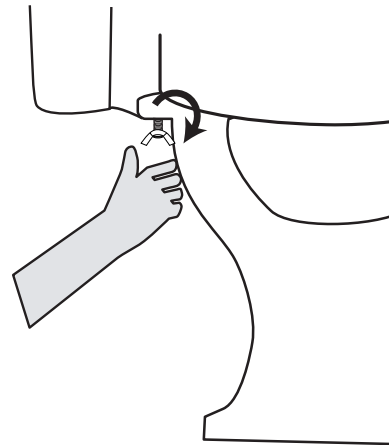

3

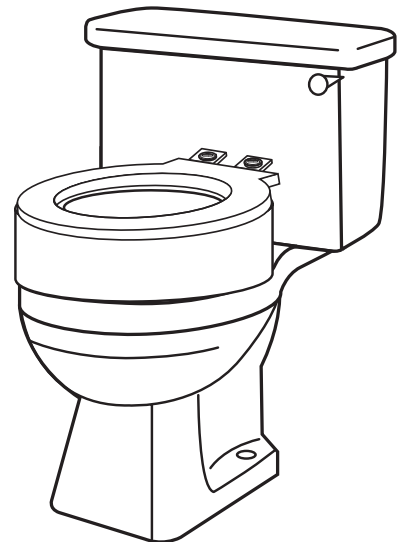

Carex Health Brands

P.O. Box 2526 • Sioux Falls, SD 57101-2526
Phone: 800-526-8051 • Fax: 888-616-4297
www.carex.com



Carex Health Brands

All Rights Reserved
Made in China • Printed in China
© 2007 Carex Health Brands